

miniPrevail® TUBE

G&H ORTHODONTICS®
Quality Manufacturing. Exceptional Service.

M.I.M.
Technology

Made in
USA

Il MiniPrevail® Tube è stato progettato pensando all'ortodontista e al paziente.

DESIGN INTELLIGENTE

Le linee di posizionamento orizzontali e verticali formano un "mirino" che agevola il posizionamento del tubo e il design consente un facile innesto del filo.

COMFORT DEL PAZIENTE

Il basso profilo e lo speciale design del gancio sono progettati per il massimo comfort del paziente.



SPECIALE DESIGN DEL GANCIO

che semplifica il posizionamento ed aumenta il comfort del paziente

SLOT SAGOMATO

ingresso a imbuto per un facile inserimento dell'arco

BASE ANATOMICA MICRO-ETCHED

E RETINA 80 MESH per aumentare la forza di adesione



GUIDE DI POSIZIONAMENTO OCCLUSALE/GENGIVALE

consentono un facile posizionamento nella regione posteriore e aiutano con piccole regolazioni prima di polimerizzare l'adesivo

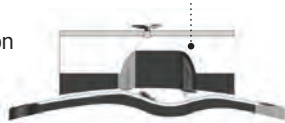

BILANCIATO

per un facile bonding



PARETI PARALLELE per una migliore presa



DISPONIBILE CON DIMENSIONE MESIODISTALE 4.2mm o 3.2mm per il totale controllo di rotazione

CODICE COLORE PERMANENTE E SPECIALE "MIRINO" con linee orizzontali e verticali per un facile posizionamento

FORMA BASE ANATOMICA per un preciso posizionamento

BASSO PROFILO tecnologia MIM acciaio inox



PARETE OCCLUSALE ANGOLATA per evitare interferenze



PRODOTTO CONSIGLIATO

Per un risultato ottimale consigliato l'utilizzo insieme ai bracket MiniPrevail® Twin

G&H ORTHODONTICS®
Quality Manufacturing. Exceptional Service.



VEDI pag. 16-17

SINGOLO

NON CONVERTIBILE 1°/2° MOLARE



miniPrevail® TUBE



1° MOLARE SUPERIORE

DIRECT BONDING

Torq.	Offset	Tec.	M/D	ID	SX/DX	.018	.022
0°	0°	STD	4.2 mm	●	DX	JNS6B-821E-10	JNS6B-221E-10
				●	SX	JNS6B-822E-10	JNS6B-222E-10
-10°	8°	Roth*	4.2 mm	●	DX	JNS6B-825E-10	JNS6B-225E-10
				●	SX	JNS6B-826E-10	JNS6B-226E-10
-14°	10°	MBT*	4.2 mm	●	DX	JNS6B-833E-10	JNS6B-233E-10
				●	SX	JNS6B-834E-10	JNS6B-234E-10
-10°	0°	MBT*	4.2 mm	●	DX	JNS6B-831E-10	JNS6B-231E-10
				●	SX	JNS6B-832E-10	JNS6B-232E-10



1° MOLARE INFERIORE

Torq.	Offset	Tec.	M/D	ID	SX/DX	.018	.022
0°	0°	STD	4.2 mm	●	DX	JNS6B-822E-10	JNS6B-222E-10
				●	SX	JNS6B-821E-10	JNS6B-221E-10
-25°	5°	Roth*	4.2 mm	●	DX	JNS6B-827E-10	JNS6B-227E-10
				●	SX	JNS6B-828E-10	JNS6B-228E-10
-20°	0°	MBT*	4.2 mm	●	DX	JNS6B-809E-10	JNS6B-209E-10
				●	SX	JNS6B-810E-10	JNS6B-210E-10
-10°	0°	MBT*	4.2 mm	●	DX	JNS6B-832E-10	JNS6B-232E-10
				●	SX	JNS6B-831E-10	JNS6B-231E-10



Articoli con codice rosso disponibili solo su prenotazione (tempi min. 15 gg. lav.)

DIRECT BONDING

1 Conf. 10 pz. € ~~62,40~~

€ 41,81

-33%

2° MOLARE SUPERIORE

DIRECT BONDING

Torq.	Offset	Tec.	M/D	ID	SX/DX	.018	.022
0°	0°	STD	3.2 mm	●	DX	JNS7B-821I-10	JNS7B-221I-10
				●	SX	JNS7B-822I-10	JNS7B-222I-10
-10°	8°	Roth*	3.2 mm	●	DX	JNS7B-825I-10	JNS7B-225I-10
				●	SX	JNS7B-826I-10	JNS7B-226I-10
-14°	10°	MBT*	3.2 mm	●	DX	JNS7B-833I-10	JNS7B-233I-10
				●	SX	JNS7B-834I-10	JNS7B-234I-10
-10°	0°	MBT*	3.2 mm	●	DX	JNS7B-831I-10	JNS7B-231I-10
				●	SX	JNS7B-832I-10	JNS7B-232I-10



2° MOLARE INFERIORE

Torq.	Offset	Tec.	M/D	ID	SX/DX	.018	.022
0°	0°	STD	3.2 mm	●	DX	JNS7B-822I-10	JNS7B-222I-10
				●	SX	JNS7B-821I-10	JNS7B-221I-10
-25°	5°	Roth*	3.2 mm	●	DX	JNS7B-827I-10	JNS7B-227I-10
				●	SX	JNS7B-828I-10	JNS7B-228I-10
-20°	0°	MBT*	3.2 mm	●	DX	JNS7B-809I-10	JNS7B-209I-10
				●	SX	JNS7B-810I-10	JNS7B-210I-10
-10°	0°	MBT*	3.2 mm	●	DX	JNS7B-832I-10	JNS7B-232I-10
				●	SX	JNS7B-831I-10	JNS7B-231I-10



Articoli con codice rosso disponibili solo su prenotazione (tempi min. 15 gg. lav.)

DIRECT BONDING

1 Conf. 10 pz. € ~~62,40~~

€ 41,81

-33%

VIPER™ LOW PROFILE BUCCAL TUBES



GANCIO A PALLA
facilmente inclinabile per evitare
decubiti e aumentare il comfort

CODICE COLORE PERMANENTE
immediata identificazione

TORQUE ALLA BASE
per favorire l'allineamento
e la rifinitura dei casi

SLOT SAGOMATO
per semplificare
l'inserimento del filo

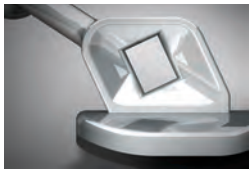

4.2MM
dimensione mesio/distale
per un controllo completo
della rotazione

TACCA DISTALE
fornisce un ancoraggio
supplementare per legature

OCCLUSAL/GENGIVAL
guida di posizionamento

BASE ANATOMICA
con ritenzione 80 mesh
per un'ottima adesione

Disponibili in due versioni:
- base E Large
- base I Small



SINGOLO NON CONVERTIBILE

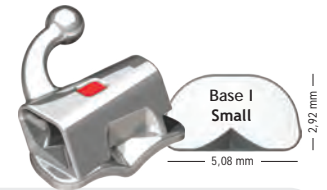

SUPERIORE

Torq.	Offset	Tec.	M/D	ID	SX/DX	DA PUNTARE		DIRECT BONDING			
						.018	.022	.018	.022	.018	.022
0°	0°	STD	4.2 mm	◆	DX	JNS3-821-10	JNS3-221-10	JNS3B-821E-10	JNS3B-221E-10	JNS3B-821I-10	JNS3B-221I-10
				◆	SX	JNS3-822-10	JNS3-222-10	JNS3B-822E-10	JNS3B-222E-10	JNS3B-822I-10	JNS3B-222I-10
-10°	8°	Roth*	4.2 mm	●	DX	JNS3-825-10	JNS3-225-10	JNS3B-825E-10	JNS3B-225E-10	JNS3B-825I-10	JNS3B-225I-10
				●	SX	JNS3-826-10	JNS3-226-10	JNS3B-826E-10	JNS3B-226E-10	JNS3B-826I-10	JNS3B-226I-10
-14°	10°	MBT*	4.2 mm	●	DX	JNS3-833-10	JNS3-233-10	JNS3B-833E-10	JNS3B-233E-10	JNS3B-833I-10	JNS3B-233I-10
				●	SX	JNS3-834-10	JNS3-234-10	JNS3B-834E-10	JNS3B-234E-10	JNS3B-834I-10	JNS3B-234I-10

INFERIORE

Torq.	Offset	Tec.	M/D	ID	SX/DX	DA PUNTARE		DIRECT BONDING			
						.018	.022	.018	.022	.018	.022
0°	0°	STD	4.2 mm	◆	DX	JNS3-822-10	JNS3-222-10	JNS3B-822E-10	JNS3B-222E-10	JNS3B-822I-10	JNS3B-222I-10
				◆	SX	JNS3-821-10	JNS3-221-10	JNS3B-821E-10	JNS3B-221E-10	JNS3B-821I-10	JNS3B-221I-10
-25°	5°	Roth*	4.2 mm	■	DX	JNS3-827-10	JNS3-227-10	JNS3B-827E-10	JNS3B-227E-10	JNS3B-827I-10	JNS3B-227I-10
				■	SX	JNS3-828-10	JNS3-228-10	JNS3B-828E-10	JNS3B-228E-10	JNS3B-828I-10	JNS3B-228I-10
-20°	0°	MBT*	4.2 mm	▲	DX	JNS3-809-10	JNS3-209-10	JNS3B-809E-10	JNS3B-209E-10	JNS3B-809I-10	JNS3B-209I-10
				▲	SX	JNS3-810-10	JNS3-210-10	JNS3B-810E-10	JNS3B-210E-10	JNS3B-810I-10	JNS3B-210I-10

DA PUNTARE

1 Conf. 10 pz. € ~~48,90~~

€ **34,23**

-30%

DIRECT BONDING

1 Conf. 10 pz. € ~~61,40~~

€ **38,07**

-38%

(*) Le versioni dei tubi presenti in questo catalogo non sono copie di altre, né la ITA O S.r.l. sostiene che siano approvate dai medici o dalle scuole menzionate.

VIPER™ CV
LOW PROFILE
BUCCAL TUBES

G&H ORTHODONTICS®
Quality Manufacturing. Exceptional Service.



GANCIO A PALLA
facilmente inclinabile per evitare
decubiti e aumentare il comfort

ESTENSIONE ANGOLATA MESIALE
della clip per facilitare la
conversione del tubo con
l'utilizzo di una pinza di utilità

SLOT SAGOMATO
per semplificare l'inserzione del filo

TORQUE ALLA BASE
per favorire l'allineamento
e la rifinitura dei casi



CAP CONVERTIBILE
saldata e brasata per evitare
la conversione accidentale

AMPIA AREA DI LEGATURA
per semplificare
la legatura del tubo

SALDATURA/BRASATURA
massima adesione del tubo
con la base mesh

BASE ANATOMICA
con ritenzione 80 mesh per
un'ottima adesione

Disponibili in due versioni:
- base E Large
- base I Small



SINGOLO CONVERTIBILE

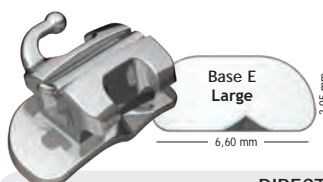

SUPERIORE

DA PUNTARE

DIRECT BONDING

Torq.	Offset	Tec.	M/D	SX/DX	.018	.022	.018	.022	.018	.022
-10°	8°	Roth*	4.2 mm	DX	JCS3-805-10	JCS3-205-10	JCS3B-805E-10	JCS3B-205E-10	JCS3B-805I-10	JCS3B-205I-10
				SX	JCS3-806-10	JCS3-206-10	JCS3B-806E-10	JCS3B-206E-10	JCS3B-806I-10	JCS3B-206I-10
-14°	10°	MBT*	4.2 mm	DX	JCS3-813-10	JCS3-213-10	JCS3B-813E-10	JCS3B-213E-10	JCS3B-813I-10	JCS3B-213I-10
				SX	JCS3-814-10	JCS3-214-10	JCS3B-814E-10	JCS3B-214E-10	JCS3B-814I-10	JCS3B-214I-10

INFERIORE

Torq.	Offset	Tec.	M/D	SX/DX	.018	.022	.018	.022	.018	.022
-25°	5°	Roth*	4.2 mm	DX	JCS3-807-10	JCS3-207-10	JCS3B-807E-10	JCS3B-207E-10	JCS3B-807I-10	JCS3B-207I-10
				SX	JCS3-808-10	JCS3-208-10	JCS3B-808E-10	JCS3B-208E-10	JCS3B-808I-10	JCS3B-208I-10
-20°	0°	MBT*	4.2 mm	DX	JCS3-815-10	JCS3-215-10	JCS3B-815E-10	JCS3B-215E-10	JCS3B-815I-10	JCS3B-215I-10
				SX	JCS3-816-10	JCS3-216-10	JCS3B-816E-10	JCS3B-216E-10	JCS3B-816I-10	JCS3B-216I-10

DA PUNTARE

1 Conf. 10 pz. € ~~54,60~~

€ **33,85**

-38%

DIRECT BONDING

1 Conf. 10 pz. € ~~69,50~~

€ **48,65**

-30%

(*) Le versioni dei tubi presenti in questo catalogo non sono copiate da altri, né la ITA.O S.r.l. sostiene che siano approvate dai medici o dalle scuole menzionate.

MORELLI



SLOT SAGOMATO
per semplificare l'inserzione del filo

**BASE TRATTATA
MEDIANTE SABBIAURA**
per un efficiente
incollaggio del tubo

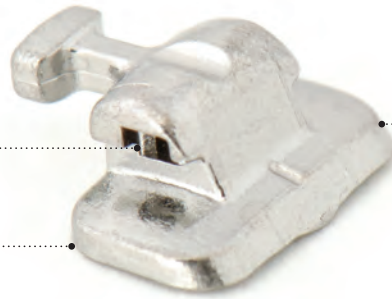

MASSIMA EFFICACIA DI ADESIONE
la base segue l'anatomia mesio-distale
e cervico-occlusale dei denti

**BASE MICROPOROSA
CON PILONCINI**
massima ritenzione dell'adesivo
e ottimo ancoraggio sui denti



SINGOLO **MORELLI**
Non CONVERTIBILE
CON GANCIO DIRITTO



SUPERIORE / INFERIORE

Torq.	Offset	SX/DX	DA PUNTARE		DIRECT BONDING	
			.018	.022	.018	.022
0°	0°	DX/SX	-	004.20.30.241	004.20.31.141	004.20.31.241

DA PUNTARE
1 Conf. 10 pz.

€ ~~33,00~~

€ 25,08

-24%

DIRECT BONDING
1 Conf. 10 pz.

€ ~~35,50~~

€ 26,98

-24%

SINGOLO **MORELLI**
Non CONVERTIBILE



Torq.	Offset	Tec.	SX/DX	DA PUNTARE	DIRECT BONDING	DIRECT BONDING
				.022	.018	.022
-14°	+14°	Roth* Superiore	DX	004.20.10.211	004.20.11.111	004.20.11.211
			SX	004.20.10.212	004.20.11.112	004.20.11.212
-30°	+4°	Roth* Inferiore	DX	004.20.10.221	004.20.11.121	004.20.11.221
			SX	004.20.10.222	004.20.11.122	004.20.11.222

DA PUNTARE
1 Conf. 10 pz.

€ ~~41,80~~

€ 29,26

-30%

DIRECT BONDING
1 Conf. 10 pz.

€ ~~46,00~~

€ 32,20

-30%

SINGOLO **MORELLI**
CONVERTIBILE
CON GANCIO DIRITTO



Torq.	Offset	Tec.	SX/DX	DA PUNTARE	DIRECT BONDING	DIRECT BONDING	
				.018	.022	.018	.022
0°	0°		DX/SX	004.20.30.180	004.20.30.280	004.20.31.180	004.20.31.280
-14°	+10°	MBT* Sup.	DX	-	-	-	004.20.35.113
			SX	-	-	-	004.20.35.114
-20°	0°	MBT* Inf.	DX/SX	-	-	-	004.20.35.212

DA PUNTARE
1 Conf. 10 pz.

€ ~~34,00~~

€ 25,50

-25%

DIRECT BONDING
1 Conf. 10 pz.

€ ~~36,60~~

€ 27,45

-25%

(*) Le versioni dei tubi presenti in questo catalogo non sono copie di altre, né la ITA.O S.r.l. sostiene che siano approvate dai medici o dalle scuole menzionate.

SLTube



NOVITÀ

TUBO AUTOLEGANTE PASSIVO

Facilità di inserimento del filo grazie a una meccanica a basso attrito. Inserimento dell'arco come su un bracket. Torque e Offset distale alla base. Base "Big Foot" con micropiloncini per un'eccellente ritenzione.

- CLIP FLESSIBILE IN NICHEL TITANIUM apribile con una semplice sonda
- COMPATIBILE CON PRESCRIZIONI M.B.T. E ROTH
- ELIMINA LA NECESSITÀ DI LEGATURE
- VELOCITÀ ED ECONOMICITÀ: riduce i tempi alla poltrona



1 CASO (UR/UL/LR/LL)
Cod. 004.20.13.900

1 Conf. 4 pz. € ~~39,00~~

DIRECT BONDING				
Torq.	Offset	Tec.	SX/DX	.022
-10°	+10°	MBT*/Roth* Superiore	DX	004.20.13.211
			SX	004.20.13.212
-25°	0°	MBT*/Roth* Inferiore	DX	004.20.13.222
			SX	004.20.13.221

DIRECT BONDING

1 Conf. 5 pz. € ~~49,00~~

€ **36,75**

-25%

€ **29,25**

-25%

VIPER™

LOW PROFILE BUCCAL TUBES



ORTHODONTICS®
Quality Manufacturing. Exceptional Service.



VIPER™ MINI TUBO DIRECT BONDING

Realizzato in Tecnologia MIM, in dimensioni ridotte (solo 2,5mm). Ideale per secondo molare o denti parzialmente erotti. Basso profilo con gancio a palla e torque alla base. Ritenzione con piloncini bidirezionali.

MINI TUBO

2° MOLARE

DIRECT BONDING						
Torq.	Offset	M/D	ID	SX/DX	.018	.022
0°	0°	2.5 mm	◆	Sup. DX/Inf. SX	JNS4B-821-10	JNS4B-221-10
			◆	Sup. SX/Inf. DX	JNS4B-822-10	JNS4B-222-10
-10°	0°	2.5 mm	●	Sup. DX	JNS4B-831-10	JNS4B-231-10
			●	Sup. SX	JNS4B-832-10	JNS4B-232-10
-14°	0°	2.5 mm	●	Sup. DX/Inf. SX	JNS4B-835-10	JNS4B-235-10
			●	Sup. SX/Inf. DX	JNS4B-836-10	JNS4B-236-10
-25°	0°	2.5 mm	■	Inf. DX	JNS4B-833-10	JNS4B-233-10
			■	Inf. SX	JNS4B-834-10	JNS4B-234-10

DIRECT BONDING

1 Conf. 10 pz. € ~~48,50~~

€ **41,23**

-15%

MINI TUBO



2° MOLARE



DIRECT BONDING					
Torq.	Offset	Tec.	SX/DX	.018	.022
-14°	0°	Roth* Sup.	DX	004.20.11.113	004.20.11.213
			SX	004.20.11.114	004.20.11.214
-25°	0°	Roth* Inf.	DX	004.20.11.123	004.20.11.223
			SX	004.20.11.124	004.20.11.224

DIRECT BONDING

1 Conf. 10 pz. € ~~39,90~~

€ **27,53**

-31%



TRASPORTE GRATUITO
PER ORDINI SUP. 200€ (AL NETTO IVA E SCONTI)



SCONTO 3% PAGAMENTO BONIFICO ANTICIPATO

MAGNUM™
BUCCAL TUBES



ORTHODONTICS®
Quality Manufacturing. Exceptional Service.



GANCIO A PALLA

facilmente inclinabile per evitare decubiti e aumentare il comfort

ESTENSIONE ANGOLATA MESIALE

della clip per facilitare la conversione del tubo con l'utilizzo di una pinza di utilità

SLOT SAGOMATO

per semplificare l'inserzione del filo

TORQUE ALLA BASE

per favorire l'allineamento e la rifinitura dei casi

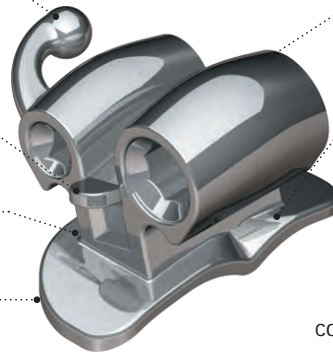

CAP CONVERTIBILE
saldata e brasata per evitare la conversione accidentale

SALDATURA/BRASATURA
massima adesione del tubo con la base mesh

BASE ANATOMICA
con ritenzione 80 mesh per un'ottima adesione



COMBINATO

MAGNUM™
BUCCAL TUBES



ORTHODONTICS®
Quality Manufacturing. Exceptional Service.

CONVERTIBILE
HG GENGIVALE

SUPERIORE

DIRECT BONDING

Torq.	Offset	Tec.	HG I.D.	Aux. Tube	M/D	SX/DX	.018	.022
-10°	8°	Roth*	.045" Geng.	-	3.5 mm	DX	JCCB-815E-10	JCCB-215E-10
						SX	JCCB-816E-10	JCCB-216E-10
-14°	10°	MBT*	.045" Geng.	-	3.5 mm	DX	-	JCC1B-217E-10
						SX	-	JCC1B-218E-10



DIRECT BONDING

1 Conf. 10 pz. € 65,40

€ 51,01

-22%

INFERIORE

Torq.	Offset	Tec.	HG I.D.	Aux. Tube	M/D	SX/DX	.018	.022
-25°	5°	Roth*	.045" Geng.	-	3.5 mm	DX	JCL1B-807E-10	JCL1B-207E-10
						SX	JCL1B-808E-10	JCL1B-208E-10

DOPPIO

MAGNUM™
BUCCAL TUBES



ORTHODONTICS®
Quality Manufacturing. Exceptional Service.

CONVERTIBILE

TUBO AUSILIARIO .018"/0°T

SUPERIORE

DA PUNTARE

DIRECT BONDING

Torq.	Offset	Tec.	HG I.D.	Aux. Tube	M/D	SX/DX	.018		.022	
							DA PUNTARE	DIRECT BONDING	DA PUNTARE	DIRECT BONDING
-10°	8°	Roth*	-	.018/0°T	3.5 mm	DX	JCD1-805-10	JCD1-205-10	JCD1B-805E-10	JCD1B-205E-10
						SX	JCD1-806-10	JCD1-206-10	JCD1B-806E-10	JCD1B-206E-10



INFERIORE

Torq.	Offset	Tec.	HG I.D.	Aux. Tube	M/D	SX/DX	.018		.022	
							DA PUNTARE	DIRECT BONDING	DA PUNTARE	DIRECT BONDING
-25°	5°	Roth*	-	.018/0°T	3.5 mm	DX	JCD1-807-10	JCD1-207-10	JCD1B-807E-10	JCD1B-207E-10
						SX	JCD1-808-10	JCD1-208-10	JCD1B-808E-10	JCD1B-208E-10
-20°	0°	MBT*	-	.018/0°T	3.5 mm	DX	JCD1-809-10	JCD1-209-10	-	JCD1B-209E-10
						SX	JCD1-810-10	JCD1-210-10	-	JCD1B-210E-10

DA PUNTARE

1 Conf. 10 pz. € 49,90

€ 40,92

-18%

DIRECT BONDING

1 Conf. 10 pz. € 65,40

€ 51,01

-22%

COMBINATO

MAGNUM
BUCCAL TUBES

G&H ORTHODONTICS[®]
Quality Manufacturing. Exceptional Service.

NON CONVERTIBILE
HG OCCLUSALE



SUPERIORE

DA PUNTARE

Torq.	Offset	Tec.	HG I.D.	Aux. Tube	M/D	SX/DX	.018	.022
0°	0°	-	.045" Occl.	-	3.5 mm	DX	JNC1-821-10	JNC1-221-10
						SX	JNC1-822-10	JNC1-222-10
-10°	8°	Roth*	.045" Occl.	-	3.5 mm	DX	JNC1-825-10	JNC1-225-10
						SX	JNC1-826-10	JNC1-226-10
-14°	10°	MBT*	.045" Occl.	-	3.5 mm	DX	-	JNC1-227-10
						SX	-	JNC1-228-10

DA PUNTARE

1 Conf. 10 pz. € ~~42,90~~

€ 26,60 **-38%**

SPAZIO
OUTLET

TANTE
OCCASIONI

SCONTI
FINO A

80%
SCONTO

itao.it OUTLET

TRIPLO

MAGNUM
BUCCAL TUBES

G&H ORTHODONTICS[®]
Quality Manufacturing. Exceptional Service.

CONVERTIBILE
HG OCCLUSALE

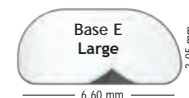

SUPERIORE

DA PUNTARE

DIRECT BONDING

Torq.	Offset	Tec.	HG I.D.	Aux. Tube	M/D	SX/DX	.018	.022	.018	.022
-10°	8°	Roth*	.045" Occl.	.018/0°T	3.5 mm	DX	JCT1-805-10	JCT1-205-10	JCT1B-805E-10	JCT1B-205E-10
						SX	JCT1-806-10	JCT1-206-10	JCT1B-806E-10	JCT1B-206E-10
-14°	10°	MBT*	.045" Occl.	.018/0°T	3.5 mm	DX	-	JCT1-207-10	-	JCT1B-207E-10
						SX	-	JCT1-208-10	-	JCT1B-208E-10

DA PUNTARE

1 Conf. 10 pz. € ~~49,90~~

€ 43,41 **-13%**

DIRECT BONDING

1 Conf. 10 pz. € ~~65,40~~

€ 51,01 **-22%**

RICKETTS TRIPLO

MAGNUM
BUCCAL TUBES

G&H ORTHODONTICS[®]
Quality Manufacturing. Exceptional Service.

NON CONVERTIBILE
HG OCCLUSALE

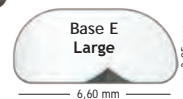

SUPERIORE

DA PUNTARE

DIRECT BONDING

Torq.	Offset	Tec.	HG I.D.	Aux. Tube	M/D	SX/DX	.018	.022	.018	.022
0°	0°	-	.045" Occl.	-	3.5 mm	DX	JNRT1-821-10	-	JNRT1B-821E-10	-
						SX	JNRT1-822-10	-	JNRT1B-822E-10	-

DA PUNTARE

1 Conf. 10 pz. € ~~66,95~~

€ 43,52 **-35%**

DIRECT BONDING

1 Conf. 10 pz. € ~~94,80~~

€ 73,94 **-22%**

(*) Le versioni dei tubi presenti in questo catalogo non sono copie di altre, né la ITA O S.r.l. sostiene che siano approvate dai medici o dalle scuole menzionate.

TUBI DIRETTI E DA PUNTARE



RICKETTS DOPPIO NON CONVERTIBILE CON GANCIO CURVO



SUPERIORE / INFERIORE

Torq.	Offset	Tec.	HG I.D.	Aux. Tube	M/D	SX/DX	.018	.022	.018	.022
0°	0°	-	-	-	3.5 mm	SUP.DX / INF.SX	JNRD1-822-10	-	JNRD1B-822E-10	-
						SUP.SX / INF.DX	JNRD1-821-10	-	JNRD1B-821E-10	-

DA PUNTARE

1 Conf. 10 pz. € ~~56,65~~

€ 44,19 **-22%**

DIRECT BONDING

1 Conf. 10 pz. € ~~67,50~~

€ 52,65 **-22%**

RICKETTS DOPPIO NON CONVERTIBILE CON GANCIO DIRITTO

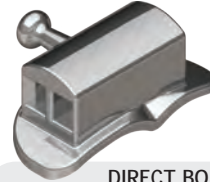

SUPERIORE / INFERIORE

Torq.	Offset	Tec.	HG I.D.	Aux. Tube	M/D	SX/DX	.018	.022	.018	.022
0°	0°	-	-	-	3.5 mm	SUP.DX / INF.SX	JNRD1-820-10	-	JNRD1B-820E-10	-
						SUP.SX / INF.DX	JNRD1-819-10	-	JNRD1B-819E-10	-

DA PUNTARE

1 Conf. 10 pz. € ~~56,65~~

€ 44,19 **-22%**

DIRECT BONDING

1 Conf. 10 pz. € ~~67,50~~

€ 52,65 **-22%**



COMBINATO CONVERTIBILE HG GENGIVALE

CAP CONVERTIBILE
saldata e brasata per evitare
la conversione accidentale

ESTENSIONE ANGOLATA
MESIALE
della clip per facilitare
la conversione del tubo
con l'utilizzo di una pinza
di utilità

SUPERIORE

Torq.	Offset	Tec.	HG I.D.	Aux. Tube	M/D	SX/DX	DA PUNTARE	
							.018	.022
-10°	8°	Roth*	.045" Geng.	-	3.5 mm	DX	JAC-815-10	JAC-215-10
						SX	JAC-816-10	JAC-216-10
-14°	10°	MBT*	.045" Geng.	-	3.5 mm	DX	-	JAC1-217-10
						SX	-	JAC1-218-10

DA PUNTARE

1 Conf. 10 pz. € ~~44,60~~

INFERIORE

Torq.	Offset	Tec.	HG I.D.	Aux. Tube	M/D	SX/DX	.018	.022
							-25°	5°
						SX	JAL1-808-10	JAL1-208-10

€ 37,02 **-17%**

PINZETTE PER TUBI E BRACKETS GEMELLARI



VEDI pag. 213

FINO A
-20%



VEDI pag. 23

-15%

DOPPIO CONVERTIBILE CON GANCIO DIRITTO



NOVITÀ

SUPERIORE / INFERIORE

Torq.	Offset	SX/DX	DA PUNTARE	DIRECT BONDING
0°	0°	DX/SX	.022 004.20.40.501	.022 004.20.41.501

DA PUNTARE
1 Conf. 10 pz. € ~~38,00~~

€ 28,12 **-26%**

DIRECT BONDING
1 Conf. 10 pz. € ~~42,00~~

€ 31,08 **-26%**

RICKETS DOPPIO NON CONVERTIBILE CON GANCIO DIRITTO



SUPERIORE / INFERIORE

Torq.	Offset	SX/DX	DA PUNTARE	DIRECT BONDING
0°	0°	DX/SX	.018 004.20.40.163	.022 004.20.41.163
			.022 004.20.40.263	.022 004.20.41.263

DA PUNTARE
1 Conf. 10 pz. € ~~38,00~~

€ 28,12 **-26%**

DIRECT BONDING
1 Conf. 10 pz. € ~~42,00~~

€ 31,08 **-26%**

DOPPIO CONVERTIBILE CON GANCIO CURVO



DIRECT BONDING

Torq.	Offset	Tec.	SX/DX	.022
-14°	+14°	Roth* Sup.	1° molare	DX 004.20.11.417
				SX 004.20.11.418
0°	+10°	Comp.Roth* Sup.	1°/2° molare	DX 004.20.11.419
				SX 004.20.11.420

DA PUNTARE
1 Conf. 10 pz. € ~~38,00~~

€ 28,88 **-24%**

DOPPIO CONVERTIBILE CON GANCIO CURVO HG GENGIVALE



DA PUNTARE

Torq.	Offset	Tec.	HG I.D.	SX/DX	.018	.022
-14°	+10°	MBT* Sup.	.045"	DX	-	004.20.35.402
				SX		004.20.35.403
-30°	+4°	Roth* Inf.	.045"	DX	004.20.10.313	004.20.10.413
				SX	004.20.10.314	004.20.10.414

DA PUNTARE
1 Conf. 10 pz. € ~~44,00~~

€ 30,80 **-30%**

TRIPLO CON GANCIO DIRITTO



SUPERIORE / INFERIORE

Torq.	Offset	Tec.	HG I.D.	SX/DX	DA PUNTARE
0°	0°		.045"	DX/SX	.018 004.20.50.180
					.022 004.20.50.181

DA PUNTARE
1 Conf. 10 pz. € ~~44,00~~

€ 31,68 **-28%**

DOPPIO CONVERTIBILE CON GANCIO DIRITTO HG GENGIVALE



SUPERIORE / INFERIORE

Torq.	Offset	HG I.D.	SX/DX	DA PUNTARE
0°	0°	.045"	DX/SX	.018 004.20.40.330
0°	0°	.051"	DX/SX	.022 004.20.40.331
				- 004.20.40.431

DA PUNTARE
1 Conf. 10 pz. € ~~42,50~~

€ 30,60 **-28%**



TUBI LINGUALI

DA PUNTARE



Tubi linguali con tacca d'innesto, con finestra, adatti come supporto per archi linguali Goshgarian, Quad-Helix, ecc.

Cod. JM040-01-10

1 Conf. 10 pz. € ~~30,90~~

€ **23,18** -25%



TUBI LINGUALI

CON GANCIO DA PUNTARE



Tubi linguali con gancio, adatti come supporto per archi linguali Goshgarian, Quad-Helix, ecc.

A) Gancio mesiale UR/LL

Cod. JM040-04-10

Gancio mesiale UL/LR

Cod. JM040-05-10

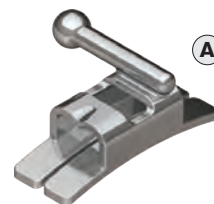

B) Gancio distale UR/LL

Cod. JM040-09-10

Gancio distale UL/LR

Cod. JM040-10-10

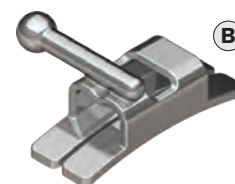

1 Conf. 10 pz. € ~~35,00~~

€ **28,00** -20%

TUBI LINGUALI

CON GANCIO DA PUNTARE



Tubo linguale con gancio universale, finestra e tacca d'innesto, adatto come supporto per archi linguali Goshgarian, Quad-Helix, ecc.

Cod. 004.20.61.206

1 Conf. 10 pz. € ~~34,00~~

€ **23,80** -30%



BOTTONI LINGUALI

DA PUNTARE



Cod. 004.30.10.105

1 Conf. 10 pz. € ~~15,00~~

€ **9,75** -35%

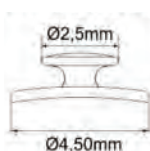

BOTTONI LINGUALI

DA PUNTARE



Base ovale piatta

Cod. JWLB20

1 Conf. 20 pz.

€ **10,99**

PREZZO SPECIALE

OFFERTA VALIDA FINO ESAURIMENTO SCORTE



CLEATS LINGUALI

DIRECT BONDING



• Small 5,3 mm
Cod. JM015B-02-10

• Large 8,1 mm
Cod. JM015B-01-10

1 Conf. 10 pz. € ~~29,15~~

€ **23,32** -20%



ALI DI GABBIANO

DA PUNTARE



Lunghezza 4,0 mm

Cod. 004.30.20.101

1 Conf. 10 pz. € ~~26,50~~

€ **18,29** -31%



OCCHIELLI

DIRECT BONDING



- Base rotonda curva
- Utili nelle trazioni di denti inclusi

Cod. 033.130.240



1 Conf. 10 pz. € ~~35,00~~

€ 31,50

-10%

OCCHIELLI

DIRECT BONDING



- Base rotonda piatta
- Utili nelle trazioni di denti inclusi

Cod. JM006B-01-10



1 Conf. 10 pz. € ~~29,80~~

€ 24,73

-17%



GANCI PER ESTRUSIONE

DIRECT BONDING



- Base rotonda curva
- Utili nelle trazioni di denti inclusi

Cod. JCIB-00-03



1 Conf. 10 pz. € ~~39,60~~

€ 30,49

-23%



BOTTONI LINGUALI MINI

DIRECT BONDING



- Base rotonda curva

Cod. JM021B-01-20



1 Conf. 20 pz. € ~~65,30~~

Base Ø 3,3mm

€ 50,93

-22%



BOTTONI LINGUALI

DIRECT BONDING



Base ovale piatta
Cod. 033.130.222



Base ovale curva
Cod. 033.130.221



1 Conf. 10 pz. € ~~34,65~~

€ 27,37

-21%

BOTTONI LINGUALI

DIRECT BONDING



Base tonda piatta
Cod. 033.130.224



Base tonda curva
Cod. 033.130.223



1 Conf. 10 pz. € ~~34,65~~

Base Ø 4mm

€ 27,03

-22%

BOTTONI LINGUALI

DIRECT BONDING



Base rotonda convessa
Cod. 004.30.10.202

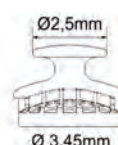

Base rotonda curva
Cod. 004.30.10.203



Base rotonda piatta
Cod. 004.30.10.205



1 Conf. 10 pz. € ~~21,50~~

€ 16,99

-21%



TRASPORTO GRATUITO
PER ORDINI SUP. 200€ (AL NETTO IVA E SCONTI)



SCONTO 3% PAGAMENTO BONIFICO ANTICIPATO

BOTTONI IN CERAMICA

DIRECT BONDING

- Può essere bondato direttamente sui denti o fissato su retainers e mascherine
- Utilizzabile lingualmente e/o labialmente
- Base anatomica piatta con ritenzione meccanica per una massima adesione
- Compatibile con tutti i tipi di adesivi

Cod. JFCB-00-01

1 Conf. 10 pz. € ~~77,50~~

€ **62,00**

-20%



Base Ø 3,5mm

GESTENCO



BOTTONI IN ZAFFIRO

DIRECT BONDING

- Ceramica di allumina policristallina
- Tecnologia C.I.M. (Ceramic Injection Molded)
- Base piatta con ritenzione chimica e meccanica
- Ideale per trattamenti con attacchi estetici e allineatori

Cod. 004.30.10.211

1 Conf. 2 pz. € ~~12,50~~

€ **7,50**

-40%



NOVITÀ

MORELLI

BOTTONI IN CERAMICA

DIRECT BONDING

- Ceramica di allumina policristallina
- Tecnologia C.I.M. (Ceramic Injection Molded)
- Base piatta con ritenzione chimica e meccanica
- Ideale per trattamenti con attacchi estetici e allineatori

Cod. 004.30.10.210

1 Conf. 2 pz. € ~~11,65~~

€ **6,99**

-40%



MORELLI

GANCI IN CERAMICA

DIRECT BONDING

- Può essere bondato direttamente sui denti o fissato su apparecchi linguali e allineatori
- Utilizzabile lingualmente e/o labialmente
- Eccellente ritenzione grazie alla base anatomica curva
- Compatibile con tutti i tipi di adesivi

Cod. JFCB-00-01HK

1 Conf. 10 pz. € ~~77,50~~

€ **62,00**

-20%



GESTENCO



Base 3,5 x 2,5 mm

BITE-BUMPER™

DIRECT BONDING

Ideali nei casi di morso profondo, facilitano l'applicazione dei brackets nell'arcata inferiore. Realizzati in polimero cristallino, possono essere usati sui pazienti allergici al nichel. Ritenzione scanalata sulla base per favorire l'adesione sul dente, si applicano come un qualsiasi bracket.

Cod. JBB-00-01

1 Conf. 10 pz. € ~~79,10~~

€ **63,28**

-20%



L'esclusiva linguetta di posizionamento rimovibile consente l'applicazione parallela dei bite-bumpers sull'elemento dentale.



Posizionamento con guida incisale



Rimozione linguetta



Bite-bumper applicato

GESTENCO

MINI MOLD

Grazie a questo sistema potete creare da soli, in pochi secondi, i vostri attacchi estetici!

- Attacchi estetici invisibili
- Si applicano in soli 5-20"
- Utilizzare adesivo fotopolimerizzabile
- Permettono di risparmiare tempo
- Ideali per pazienti con problemi di allergie

MINI MOLD KIT

E' un pratico kit contenente tutte le tipologie di prodotto, ideale per testarle e successivamente fare una scelta.

- Un kit è composto da:
- 27 capsule Mini Mold (3 per tipo)
 - 1 manico
 - istruzioni dettagliate

Cod. 033.550.100

1 Kit € ~~198,00~~

€ **168,30**

-15%



MINI MOLD RIFORMIMENTI

I Mini Mold sono disponibili in sette differenti versioni.

Le confezioni di Mini Mold contengono: **8 o 10 capsule, 1 applicatore e istruzioni per l'uso dettagliate passo per passo.**

Le capsule Mini Mold, riutilizzabili per più applicazioni, sono sterilizzabili a freddo.

1 Conf. € ~~72,60~~

€ **65,34**

-10%

RETRATTORI LINGUALI



Per creare ritentori linguali con fili fino a .020".

Large - 4,5 mm Cod. 033.550.160
Small - 3 mm Cod. 033.550.165

1 Conf. 10 pz.

CONTROLLO ABITUDINI



Le piccole punte coniche mettono fine alla cattiva abitudine di succhiare il pollice e di spingere la lingua contro i denti.

Cod. 033.550.140

1 Conf. 10 pz.

BOTTONI

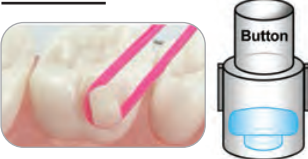

Per creare velocemente bottoni a basso profilo.

Cod. 033.550.120

1 Conf. 10 pz.

RIALZI MOLARI

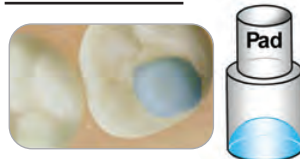

Per aprire il morso a partire dai denti posteriori.

Cod. 033.550.150

1 Conf. 10 pz.

RIALZO DEL MORSO



Applicate sulla superficie linguale degli incisivi superiori, creano un rialzo del morso.

Large - 5 mm Cod. 033.550.105
Small - 3 mm Cod. 033.550.103

1 Conf. 8 pz.

TUBI MOLARI

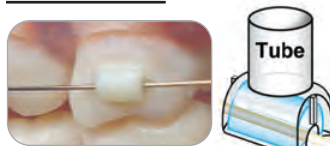

Per creare tubi molari temporanei per fili rotondi fino a .020".

Cod. 033.550.130

1 Conf. 10 pz.



FASE 1

FASE 2

Riempire la capsula del Mini Mold scelto con un composito fotopolimerizzabile.

Posizionare la capsula del Mini Mold sul dente da trattare. Fotopolimerizzare per 5-20 secondi.

PRODOTTI CONSIGLIATI



Resina Assure® Plus

Cod. JPLUS

VEDI pag. 95

Composito fluido Flow Tain™

Cod. JFT VEDI pag. 98



ATTACCHI DIRETTI



Per creare attacchi secondo la tecnica Edgewise con slot .022".

Cod. 033.550.110

1 Conf. 10 pz.



TS₂ RAPID OPEN BITE CORRECTION

CORRETTORE PER IL MORSO APERTO



Progettato dal Dr. John Voudouris, TS2 è un dispositivo completamente invisibile e ben tollerato dai pazienti per il suo elevato comfort ed i ridotti tempi del trattamento. Il morso aperto viene risolto in meno di 4-6 mesi con l'utilizzo congiunto di elastici intraorali leggeri.

TS2 va posizionato sul lato linguale da 3-3 superiore e/o da 3-3 inferiore. Le leggere protrusioni agiscono come sistemi educativi della lingua per prevenirne il suo posizionamento anteriore, mentre gli ampi sottosquadri consentono l'utilizzo di elastici intraorali per la correzione del cross bite.

LE 9 PROTRUSIONI preven-
gono la spinta della lingua sui denti anteriori (TS2 non taglia la lingua, i guanti dell'operatore o la pelle)

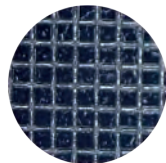

Basetta con retina 80 mesh per una maggiore resistenza ritentiva

6 SOTTOSQUADRI da utilizzare con elastici per morso crociato e nel trattamento del morso aperto laterale che generalmente richiede l'espansione mascellare



Cod. 033.130.100

1 Conf. 12 pz. € ~~69,30~~

€ **62,37**

-10%

INIBITORE per la lingua dalle dimensioni molto contenute per una corretta igiene orale

BT₂ RAPID DEEP OVERBITE CORRECTOR

CORRETTORE PER IL MORSO PROFONDO



Progettato dal Dr. John Voudouris, BT2 è un dispositivo per il trattamento di malocclusioni scheletriche del morso profondo. Posizionato sul lato palatale degli incisivi centrali superiori è la chiave per la Correzione Rapida di Deep overbite (RDC).

La speciale curvatura riduce l'iperattività muscolare e le parafunzioni, guidando gli incisivi inferiori nell'apertura del morso ed evitando interferenze con quelli superiori.

Riduce il tempo alla poltrona e permette la soluzione di over bite profondi in 4-6 mesi sia nei bambini sia negli adulti. Utile anche per l'apertura del morso nelle III° Classi se posizionato sugli incisivi centrali inferiori.

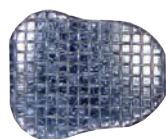
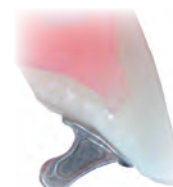

Basetta ampia e anatomica, con retina 80 mesh, progettata per una corretta adesione sulla superficie linguale degli incisivi, assicurando un'elevata resistenza al distacco.

INNOVATIVO INTAGLIO VERTICALE che aiuta il posizionamento del dispositivo e, se compresso con uno strumento, ne facilita la rimozione.

ESTREMITÀ ARROTONDATE

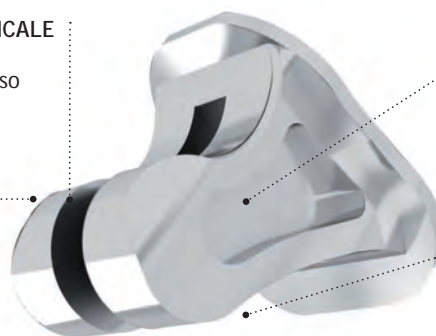

SCANALATURE LATERALI per facilitare la presa del dispositivo.

CURVATURA BREVETTATA per consentire uno sviluppo neurale precoce del percorso di crescita anteriore, evitando interferenze degli incisivi durante l'occlusione.



Cod. 033.130.200

1 Conf. 10 pz. € ~~80,85~~

€ **72,77**

-10%



ERUPTION CHAINS GOLD

DIRECT BONDING

Occhielli con catenella placcati oro 24k con base D.B. utili per le trazioni di denti inclusi.

GESTENCO

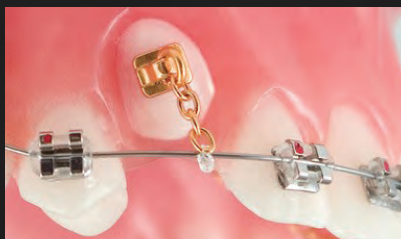

OCCHIELLO CON BASE ROTONDA CURVA



Maglia per filo .030"
Base Ø 3,5 mm

Cod. JEE-00-02

1 Conf. 5 pz. € ~~142,00~~



€ 113,60 **-20%**

OCCHIELLO CON BASE QUADRA CURVA



Maglia per filo .030"
Base 4 x 3 mm

Cod. JEE-00-03

1 Conf. 5 pz. € ~~142,00~~



€ 113,60 **-20%**

OCCHIELLO CON BASE OVALE CURVA



Maglia per filo .030"
Base 4,2 x 2,9 mm

Cod. JEE-00-01

1 Conf. 5 pz. € ~~142,00~~



€ 113,60 **-20%**

GANCIO CON BASE ROTONDA CURVA



Maglia per filo .025"
Base Ø 3,5 mm

Cod. JEE-00-04

1 Conf. 5 pz. € ~~155,00~~



€ 124,00 **-20%**

ERUPTION CHAINS IN TITANIO

DIRECT BONDING

Bottone a catenella in titanio, con base ritentiva strutturata al laser, utile per le trazioni di denti inclusi.

D
DENTAURUM



Maglia per filo .030"
Base Ø 3 mm

Cod. DE750-003-51

1 Conf. 1 pz.



PREZZO SPECIALE
€ 23,60

TITAN™ BANDE MOLARI ANATOMICHE



Le bande Titan sono realizzate con acciaio di una speciale tempra, che le rende resistenti e facilmente modellabili alla superficie dei denti. Nella parte interna presentano una superficie microincisa per aumentare la ritenzione dei cementi.

Disponibili per 1°/2° molare superiore in 30 misure e 2° molare inferiore in 27 misure.

Vendute in confezioni rifornimento da 10 pezzi per misura nude o prepuntate e in kits.



BORDI ARROTONDATI
Per il massimo comfort del paziente

FORMA ANATOMICA
Per un facile posizionamento sul dente



MARCATURA PERMANENTE
con processo ECE (Electro Chemical Etching) per una facile identificazione

MICRO INCISIONI
nella superficie interna per un'ottima ritenzione

CONTENITORI PER BANDE E PINZE RIMUOVI BANDE

VEDI pag. 175



**FINO A
-60%**



VEDI pag. 195

TITAN™ BANDE MOLARI ANATOMICHE



1°/2° MOLARE



Misura	1°/2° Molare Sup. DX	1°/2° Molare Sup. SX	1° Molare Inf. DX	1° Molare Inf. SX	2° Molare Inf. DX	2° Molare Inf. SX
29,5	JB10-UR-295-10	JB10-UL-295-10	JB10-LR-295-10	JB10-LL-295-10	JB11-LR-295-10	JB11-LL-295-10
30	JB10-UR-300-10	JB10-UL-300-10	JB10-LR-300-10	JB10-LL-300-10	JB11-LR-300-10	JB11-LL-300-10
30,5	JB10-UR-305-10	JB10-UL-305-10	JB10-LR-305-10	JB10-LL-305-10	JB11-LR-305-10	JB11-LL-305-10
31	JB10-UR-310-10	JB10-UL-310-10	JB10-LR-310-10	JB10-LL-310-10	JB11-LR-310-10	JB11-LL-310-10
31,5	JB10-UR-315-10	JB10-UL-315-10	JB10-LR-315-10	JB10-LL-315-10	JB11-LR-315-10	JB11-LL-315-10
32	JB10-UR-320-10	JB10-UL-320-10	JB10-LR-320-10	JB10-LL-320-10	JB11-LR-320-10	JB11-LL-320-10
32,5	JB10-UR-325-10	JB10-UL-325-10	JB10-LR-325-10	JB10-LL-325-10	JB11-LR-325-10	JB11-LL-325-10
33	JB10-UR-330-10	JB10-UL-330-10	JB10-LR-330-10	JB10-LL-330-10	JB11-LR-330-10	JB11-LL-330-10
33,5	JB10-UR-335-10	JB10-UL-335-10	JB10-LR-335-10	JB10-LL-335-10	JB11-LR-335-10	JB11-LL-335-10
34	JB10-UR-340-10	JB10-UL-340-10	JB10-LR-340-10	JB10-LL-340-10	JB11-LR-340-10	JB11-LL-340-10
34,5	JB10-UR-345-10	JB10-UL-345-10	JB10-LR-345-10	JB10-LL-345-10	JB11-LR-345-10	JB11-LL-345-10
35	JB10-UR-350-10	JB10-UL-350-10	JB10-LR-350-10	JB10-LL-350-10	JB11-LR-350-10	JB11-LL-350-10
35,5	JB10-UR-355-10	JB10-UL-355-10	JB10-LR-355-10	JB10-LL-355-10	JB11-LR-355-10	JB11-LL-355-10
36	JB10-UR-360-10	JB10-UL-360-10	JB10-LR-360-10	JB10-LL-360-10	JB11-LR-360-10	JB11-LL-360-10
36,5	JB10-UR-365-10	JB10-UL-365-10	JB10-LR-365-10	JB10-LL-365-10	JB11-LR-365-10	JB11-LL-365-10
37	JB10-UR-370-10	JB10-UL-370-10	JB10-LR-370-10	JB10-LL-370-10	JB11-LR-370-10	JB11-LL-370-10
37,5	JB10-UR-375-10	JB10-UL-375-10	JB10-LR-375-10	JB10-LL-375-10	JB11-LR-375-10	JB11-LL-375-10
38	JB10-UR-380-10	JB10-UL-380-10	JB10-LR-380-10	JB10-LL-380-10	JB11-LR-380-10	JB11-LL-380-10
38,5	JB10-UR-385-10	JB10-UL-385-10	JB10-LR-385-10	JB10-LL-385-10	JB11-LR-385-10	JB11-LL-385-10
39	JB10-UR-390-10	JB10-UL-390-10	JB10-LR-390-10	JB10-LL-390-10	JB11-LR-390-10	JB11-LL-390-10
39,5	JB10-UR-395-10	JB10-UL-395-10	JB10-LR-395-10	JB10-LL-395-10	JB11-LR-395-10	JB11-LL-395-10
40	JB10-UR-400-10	JB10-UL-400-10	JB10-LR-400-10	JB10-LL-400-10	JB11-LR-400-10	JB11-LL-400-10
40,5	JB10-UR-405-10	JB10-UL-405-10	JB10-LR-405-10	JB10-LL-405-10	JB11-LR-405-10	JB11-LL-405-10
41	JB10-UR-410-10	JB10-UL-410-10	JB10-LR-410-10	JB10-LL-410-10	JB11-LR-410-10	JB11-LL-410-10
41,5	JB10-UR-415-10	JB10-UL-415-10	JB10-LR-415-10	JB10-LL-415-10	JB11-LR-415-10	JB11-LL-415-10
42	JB10-UR-420-10	JB10-UL-420-10	JB10-LR-420-10	JB10-LL-420-10	JB11-LR-420-10	JB11-LL-420-10
42,5	JB10-UR-425-10	JB10-UL-425-10	JB10-LR-425-10	JB10-LL-425-10	JB11-LR-425-10	JB11-LL-425-10
43	JB10-UR-430-10	JB10-UL-430-10	JB10-LR-430-10	JB10-LL-430-10	-	-
43,5	JB10-UR-435-10	JB10-UL-435-10	JB10-LR-435-10	JB10-LL-435-10	-	-
44	JB10-UR-440-10	JB10-UL-440-10	JB10-LR-440-10	JB10-LL-440-10	-	-



1° molare inferiore



2° molare inferiore



1° e 2° molare superiore

RIFORNIMENTI
PER SINGOLA MISURA
1 Conf. 10 pz. € 30,30

€ 24,24 **-20%**

**A RICHIESTA SCONTI
SU QUANTITATIVI**

☎ 051 6240560
📱 378 3025975 WhatsApp

**A RICHIESTA TELEFONICA
POSSIBILITÀ DI CAMPIONE
PER PROVA GRATUITA**

☎ 051 6240560
📱 378 3025975
WhatsApp

TABELLA DI CONVERSIONE BANDE



1°/2° MOLARE SUPERIORE

G&H Orthodontics				29.5		30	30.5			31		31.5		32		32.5		33		33.5		34		34.5		35		35.5		36			36.5		
American Orthodontics											1.5		2				2.5	3				3.5		4		4.5		5		5.5		6			
Dentaurum Dentaform		2	3	4		5	6		7		8		9		10		11	12				13		14		15		16		17		18		19	20
GAC-SnapFit				1		2				3		4		5		6				7		8		9		10		11		12		13		14	
Ormco Standard			1	2	3		4	5	6		7		8		9		10	11				12	13	14	15				17	18	19				
Ormco Ultima								5	6	7	8						10	11				12	13	14		15		16	17		18	19	20		
Ormco Washbon				1		2	3		4		5		6	7	8	9	10				11		12	13	14	15		16		17		18	19		
RMO Truform	1	2	3	4	5		6		7		8		9		10		11	12				13		14		15		16	17	18					
TP GripTite				00		0			1	2			3		5		6	7	8			9	10	11	12	13		14	15	16	17	18	19		
Unitek Victory Series		29	29.5		30	30.5			31		31.5		32		32.5		33		33.5		34		34.5		35		35.5		36			36.5			
Ortho Org. Tempra			29.5		30	30.5			31		31.5		32		32.5		33		33.5		34		34.5		35		35.5		36			36.5			

1° MOLARE INFERIORE

G&H Orthodontics				29.5		30			30.5		31		31.5		32		32.5		33			33.5		34		34.5		35		35.5			36
American Orthodontics											1.5		2		2.5				3				3.5				4		4.5		5		
Dentaurum Dentaform			3	4		5		6	7	8	9	10	11	12		13	14				15	16		17		18		19		20	21	22	
GAC-SnapFit				1					2			3		4		5		6				7		8		9		10		11	12	13	
Ormco Original					1		2		3	4	5	6	7	8		9	10		11		12	13	14				16	17	18				
Ormco Ultima											5	7		8	9		10		11	12		13		14		15		16	17	18			
Ormco Washbon				1							5		6		7		8	9				10	11	12	13	14	15	16		17	18		
RMO Truform	1	2	3		4	5			6		7		8		9		10				11	12		13		14		15	16	17			
TP GripTite					00			0		1	2			4	5	6	7		8		9	10		11		12		13	14	15	16	17	18
Unitek Victory Series			29.5		30		30.5		31		31.5		32		32.5		33		33.5		34		34.5		35		35.5		36				
Ortho Org. Tempra			29.5		30		30.5		31		31.5		32		32.5		33		33.5		34		34.5		35		35.5		36				

2° MOLARE INFERIORE

G&H Orthodontics				29.5		30		30.5		31		31.5		32		32.5		33		33.5		34		34.5		35		35.5		36		36.5	37
American Orthodontics										1.5		2		2.5				3	3.5				4	4.5			5	5.5		6	6.5	7	7.5
Dentaurum Dentaform				1	2		3	4	5		6	7	8	9	10		11		12	13		14	15		16		17	18	19	20			
GAC-SnapFit	1	2	3	4		5		6		7	8		9		10		11		12	13		14		15	16	17		18		19	20	21	
Ormco Standard					1	2		3		4	5		6	7		8	9	10				11	12	13		14	15	16		17	18	19	
Ormco Washbon				1	2		3		4		5	6	7		8		9	10	11			12		13		14	15	16		17	18	19	20
RMO Truform										7	8		9		10		11				12	13		14	15	16	17		18	19	20		
TP GripTite				00		0		1	2	3		4	5	6	7	8		9	10	11		12	13	14	15	16	17	18	19	20	21		
Unitek Contoured			29.5		30		30.5		31		31.5		32		32.5		33		33.5		34		34.5		35		35.5		36		36.5	37	
Ortho Org. Tempra			29.5		30		30.5		31		31.5		32		32.5		33		33.5		34		34.5		35		35.5		36		36.5	37	

Nota: le informazioni sulle comparazioni delle bande riportate in tabella sono da intendersi puramente indicative.



ASSORTIMENTI IN KITS

Le bande Titan™ sono disponibili in vari assortimenti:

TRIAL KIT
80 bande
(40 destre e 40 sinistre)

INTRO KIT
150 bande
(75 destre e 75 sinistre)

PRO KIT
300 bande
(150 destre e 150 sinistre)

Confezionati nei pratici organizers



KITS PER PRIMO E SECONDO MOLARE SUPERIORE

Kit Bande Molari anatomiche	29.5	30	30.5	31	31.5	32	32.5	33	33.5	34	34.5	35	35.5	36	36.5	37	37.5	38	38.5	39	39.5	40	40.5	41	41.5	42	42.5	43	43.5	44
Trial Kit 1° e 2° molare superiore 80 Bande	-	-	-	-	-	2	2	4	4	4	6	6	10	10	10	6	6	4	4	2	-	-	-	-	-	-	-	-	-	-
Intro Kit 1° e 2° molare superiore 150 Bande	2	2	2	2	2	2	4	4	6	8	10	10	10	10	12	12	10	8	6	4	4	4	2	2	2	2	2	2	2	
Pro Kit 1° e 2° molare superiore 300 Bande	4	4	4	4	4	4	8	8	12	16	20	20	20	20	24	24	20	16	12	8	8	8	4	4	4	4	4	4	4	

TRIAL KIT 1° e 2° mol.sup. 80 bande
cod. JK10-UP-TRIAL

€ 259,00 **€ 199,43** **-23%**

INTRO KIT 1° e 2° mol.sup. 150 bande
cod. JK10-UP-INTRO

PREZZO SPECIALE
a solo € **368,22**

PRO KIT 1° e 2° mol.sup. 300 bande
cod. JK10-UP-PRO

PREZZO SPECIALE
a solo € **697,68**

Articoli con codice rosso disponibili solo su prenotazione (tempi min. 15 gg. lav.)

KITS PER PRIMO MOLARE INFERIORE

Kit Bande Molari anatomiche	29.5	30	30.5	31	31.5	32	32.5	33	33.5	34	34.5	35	35.5	36	36.5	37	37.5	38	38.5	39	39.5	40	40.5	41	41.5	42	42.5	43	43.5	44
Trial Kit 1° molare inferiore 80 Bande	-	-	-	-	-	2	2	4	4	4	6	6	10	10	10	6	6	4	4	2	-	-	-	-	-	-	-	-	-	
Intro Kit 1° molare inferiore 150 Bande	2	2	2	2	2	2	4	4	6	8	10	10	10	10	12	12	10	8	6	4	4	4	2	2	2	2	2	2	2	
Pro Kit 1° molare inferiore 300 Bande	4	4	4	4	4	4	8	8	12	16	20	20	20	20	24	24	20	16	12	8	8	8	4	4	4	4	4	4	4	

TRIAL KIT 1° mol.inf. 80 bande
cod. JK10-LO-TRIAL

€ 259,00 **€ 199,43** **-23%**

INTRO KIT 1° mol.inf. 150 bande
cod. JK10-LO-INTRO

PREZZO SPECIALE
a solo € **368,22**

PRO KIT 1° mol.inf. 300 bande
cod. JK10-LO-PRO

PREZZO SPECIALE
a solo € **697,68**

Articoli con codice rosso disponibili solo su prenotazione (tempi min. 15 gg. lav.)

KITS PER SECONDO MOLARE INFERIORE

Kit Bande Molari anatomiche	29.5	30	30.5	31	31.5	32	32.5	33	33.5	34	34.5	35	35.5	36	36.5	37	37.5	38	38.5	39	39.5	40	40.5	41	41.5	42
Trial Kit 2° molare inferiore 80 Bande	-	-	-	-	-	2	2	4	4	4	6	6	10	10	10	6	6	4	4	2	-	-	-	-	-	-
Intro Kit 2° molare inferiore 150 Bande	2	2	2	2	2	2	4	6	8	8	10	10	10	10	12	12	10	8	8	6	4	4	2	2	2	2
Pro Kit 2° molare inferiore 300 Bande	4	4	4	4	6	8	8	8	12	14	16	18	20	24	24	24	20	18	16	12	10	6	6	6	4	4

TRIAL KIT 2° mol.inf. 80 bande
cod. JK11-LO-TRIAL

€ 259,00 **€ 199,43** **-23%**

INTRO KIT 2° mol.inf. 150 bande
cod. JK11-LO-INTRO

PREZZO SPECIALE
a solo € **368,22**

PRO KIT 2° mol.inf. 300 bande
cod. JK11-LO-PRO

PREZZO SPECIALE
a solo € **697,68**

Articoli con codice rosso disponibili solo su prenotazione (tempi min. 15 gg. lav.)

FOGLI TERMIFORMABILI PER ALIGNERS E RETAINERS

Disponibili in Poliuretano e PETG

- RESISTENTE ALLE ROTTURE
- ULTRA TRASPARENTE
- BPA FREE



VEDI
OFFERTA
pag. 212-214